

NuDAQ[®]
723X Series
32 Channels Isolated
Digital I/O Card
User's Manual



Recycled Paper

© Copyright 1996~2001 ADLINK Technology Inc.
All Rights Reserved.

Manual Rev 3.22: October 23, 2001

The information in this document is subject to change without prior notice in order to improve reliability, design and function and does not represent a commitment on the part of the manufacturer.

In no event will the manufacturer be liable for direct, indirect, special, incidental, or consequential damages arising out of the use or inability to use the product or documentation, even if advised of the possibility of such damages.

This document contains proprietary information protected by copyright. All rights are reserved. No part of this manual may be reproduced by any mechanical, electronic, or other means in any form without prior written permission of the manufacturer.

Trademarks

NuDAQ, NuIPC, DAQBench are registered trademarks of ADLINK Technology Inc.,

Other product names mentioned herein are used for identification purposes only and may be trademarks and/or registered trademarks of their respective companies.

Getting service from ADLINK

Customer Satisfaction is always the most important thing for ADLINK Technology Inc. If you need any help or service, please contact us and get it.

ADLINK Technology Inc.			
Web Site	http://www.adlink.com.tw http://www.adlinktechnology.com		
Sales & Service	service@adlink.com.tw		
Technical Support	NuDAQ	nudaq@adlink.com.tw	
	NuDAM	nudam@adlink.com.tw	
	NuIPC	nuipc@adlink.com.tw	
	NuPRO	nupro@adlink.com.tw	
	Software	sw@adlink.com.tw	
TEL	+886-2-82265877	FAX	+886-2-82265717
Address	9F, No. 166, Jian Yi Road, Chungho City, Taipei, 235 Taiwan, R.O.C.		

Please inform or FAX us of your detailed information for a prompt, satisfactory and constant service.

Detailed Company Information			
Company/Organization			
Contact Person			
E-mail Address			
Address			
Country			
TEL		FAX	
Web Site			

Questions	
Product Model	
Environment to Use	<input type="checkbox"/> OS _____ <input type="checkbox"/> Computer Brand _____ <input type="checkbox"/> M/B: _____ <input type="checkbox"/> CPU: _____ <input type="checkbox"/> Chipset: _____ <input type="checkbox"/> BIOS: _____ <input type="checkbox"/> Video Card: <input type="checkbox"/> Network Interface Card: <input type="checkbox"/> Other:
Challenge Description	
Suggestions for ADLINK	

Table of Contents

Chapter 1 Introduction	1
1.1 FEATURES	2
1.1.1 PCI-7230 and cPCI-7230 Features.....	2
1.1.2 PCI-7233/H and Features.....	2
1.1.4 PCI-7234 Features.....	2
1.2 SPECIFICATIONS OF PCI-7230/cPCI-7230.....	3
1.3 SPECIFICATIONS OF PCI-7233/PCI-7233H.....	4
1.4 SPECIFICATIONS OF PCI-7234.....	5
1.5 SOFTWARE SUPPORTING.....	5
1.5.1 Programming Library.....	6
1.5.2 PCIS-LVIEW: LabVIEW [®] Driver.....	6
1.5.3 PCIS-VEE: HP-VEE Driver.....	6
1.5.4 DAQBench [™] : ActiveX Controls.....	7
1.5.5 DASylab [™] PRO.....	7
1.5.6 PCIS-DDE: DDE Server and InTouch [™]	7
1.5.7 PCIS-ISG: ISaGRAF [™] driver.....	7
1.5.8 PCIS-ICL: InControl [™] Driver.....	7
1.5.9 PCIS-OPC: OPC Server.....	7
Chapter 2 Installation	8
2.1 WHAT YOU HAVE	8
2.2 UNPACKING.....	9
2.3 HARDWARE INSTALLATION OUTLINE	10
2.4 DEVICE INSTALLATION FOR WINDOWS SYSTEMS.....	10
2.5 CONNECTOR PIN ASSIGNMENT	11
2.5.1 PCI-7230 Pin Assignment.....	11
2.5.2 cPCI-7230 Pin Assignment.....	12
2.5.3 PCI-7233 Pin Assignment.....	13
2.5.4 PCI-7234 Pin Assignment.....	14
2.6 TERMINATION BOARD CONNECTION	15
Chapter 3 Registers Format	16
3.1 PCI PNP REGISTERS.....	16
3.2 I/O REGISTERS FORMAT	17
3.3 DIGITAL INPUT REGISTER	18
3.4 DIGITAL OUTPUT REGISTER	18
Chapter 4 Operation Theorem	19
4.1 ISOLATED DIGITAL INPUT CIRCUITS.....	19

4.2	ISOLATED DIGITAL OUTPUT CIRCUITS.....	20
4.3	CHANGE OF STATE DETECTION	21
4.3.1	<i>What is COS?.....</i>	21
4.3.2	<i>Structure of COS detection & Dual Interrupt System.....</i>	21
4.3.3	<i>COS Detection.....</i>	22
Chapter 5 C/C++ Libraries		23
5.1	LIBRARIES INSTALLATION	23
5.2	PROGRAMMING GUIDE.....	24
5.2.1	<i>Naming Convention.....</i>	24
5.2.2	<i>Data Types.....</i>	24
5.3	INITIALIZATION	25
5.4	DIGITAL INPUT	26
5.5	DIGITAL OUTPUT	27
5.6	INTERRUPT RELATIVE FUNCTIONS	28
5.6.1	<i>_723X_Set_INT_Control.....</i>	28
5.6.2	<i>_723X_Get_IRQ_Status.....</i>	29
5.6.3	<i>_723X_CLR_IRQ.....</i>	30
5.6.4	<i>Interrupt Enable.....</i>	30
5.6.5	<i>Interrupt Disable.....</i>	31
Product Warranty/Service		32

How to Use This Guide

This manual is designed to help you use the PCI-6308. It describes how to modify and control various functions on the PCI-6308 card to meet your requirements. It is divided into three chapters:

- **Chapter 1**, "Introduction", gives an overview of the product features, applications, and specifications.
- **Chapter 2**, "Installation", describes how to install the 723X products. The PCB layout is shown, the connectors specifications, and the notes for installation are described.
- **Chapter 3**, "Register Format", describes details on-board register format. It is very useful to understand the lowest level of controlling the boards.
- **Chapter 4**, "Operation Theorem", describes more details about the operation of DIO and COS system.
- **Chapter 5**, "C/C++ Library", describes the functions in the DOS C/C++ Library and Windows 95 DLL.



Introduction

This manual describes the contents of PCI-723X family products. Include:

- PCI-7230: Isolated 16-CH DI and 16-CH DI Card
- PCI-7233: Isolated 32-CH DI Card with COS detection
- PCI-7233H: Isolated High-speed 32-CH DI Card with COS
- PCI-7234: Isolated 32-CH DO Card
- cPCI-7230: Isolated 16-CH DI and 16-CH DI Module for 3U CompactPCI

These products are with high isolation voltage and 32 DI or DO channels. The high isolation voltage protects your computer against damage caused by accidental contact with high external voltage and eliminates troublesome ground loops.

The PCI-7230/cPCI-7230 provides 32 isolated digital I/O, 16 Isolated inputs and 16 isolated outputs. The isolated I/O channels are isolated to 5,000 Vrms (excluding cables).

The PCI-7233 provides 32 isolated digital input channels with COS (change-of-state detection). The high speed version PCI-7233H provides 32-CH isolated digital input .The isolation voltage of PCI-7233H is high up to 2,500 Vrms (excluding cables).

The PCI-7234 provides 32 isolated digital output (Darlington transistor) channels. The isolation voltage is high up to 5,000 Vrms (excluding cables), both channel-to-channel and channel-to-computer.

The PCI-7230/7233/7234 use ASIC PCI controller to interface the board to the PCI bus. The ASIC fully implement the PCI local bus specification Rev 2.1. All bus relative configurations, such as base memory address and interrupt assignment, are automatically controlled by BIOS software. It does not need any user interaction and pre-study for the configurations. This removes the burden of searching for a conflict-free configuration, which can be very time-consuming and difficult with some other bus standards.

1.1 Features

1.1.1 PCI-7230 and cPCI-7230 Features

- 16 Isolated Digital Input Channels
- 16 Isolated Digital Output Channels
- High output driving capability
- 2,500 Vrms high voltage isolation
- Interrupt is controlled from external signal
- Dual interrupt trigger
- 200mA sink current on isolated output channels
- Up to 24V voltage protection for isolated input
- 37-pin D-type connector

1.1.2 PCI-7233/H and Features

- 32 Isolated Digital Input Channels
- 5000 Vrms high voltage isolation
- Up to 24V voltage protection for isolated input
- Interrupt is generated by COS (change-of-state) detection
- Dual interrupt trigger
- High-speed isolator (1ms) version PCI-7233H available with 2500 Vrms isolation voltage
- 37-pin D-type connector

1.1.4 PCI-7234 Features

- 32 Isolated Digital Output Channels
- High output driving capability
- 200mA sink current on isolated output channels
- 5,000 Vrms high voltage isolation
- 37-pin D-type connector

1.2 Specifications of PCI-7230/cPCI-7230

◆ Isolated Digital I/O (DIO)

· Optical Isolated Input Channel

Numbers of Channel: 16 digital inputs

Input Voltage: up to 24Vdc

- Logic "L": 0~2.4V
- Logic "H": 3~24V

Input resistance: 1.2K Ω @ 0.5W

Isolated voltage: 5000 Vrms

Throughput: 10K Hz

• Optical Isolated Output channel

Numbers of Channel: 16 digital outputs

Output type: Darlington transistors

Output Voltage: open collector 5V (min.), up to 35V_{DC} (max.)

Sink Current:

- 500 mA max @ 100 % duty, for one of the 8 transistor device ON
- 370 mA @ duty 10% for all transistors devices ON
- 140 mA @ duty 50% for all transistors devices ON

(Note: the pulse width is 25ms for one duty cycle.)

Isolated voltage: 5000 Vrms

Throughput: 10K Hz

• Interrupt sources

Channel 0 and channel 1 of digital input channels

◆ General Specifications

- **Connector:** 37-pin D-type connector for PCI-7230
50-pin SCSI-II type connector for cPCI-7230

- **Operating Temperature:** 0° C ~ 60° C

- **Storage Temperature:** -20° C ~ 80° C

- **Humidity:** 5 ~ 95%, non-condensing

- **Power Consumption:**

PCI-7230: +5 V @ 150 mA (typical) [Note: Need external power]

cPCI-7230: +5 V @ 270 mA (typical)

- **Dimension:** Compact size

PCI-7230 153mm(L) X 107mm(H)

cPCI-7230 Standard 3U CompactPCI form factor

1.3 Specifications of PCI-7233/PCI-7233H

◆ Isolated Digital Input

• Optical Isolated Input Channel (PCI-7233)

Numbers of Channel: 32 digital inputs

Input Voltage: up to 24Vdc

- Logic "L": 0~2.4V
- Logic "H": 3~24V

Input resistance: 1.2 K Ω @ 0.5W

Isolated voltage: 5000 V rms

Throughput: 10K Hz

• Optical Isolated Input Channel (PCI-7233H)

Numbers of Channel: 32 digital inputs

Input Voltage: up to 24Vdc

- Logic "L": 0~3.2V
- Logic "H": 3.5~24V

Input resistance: 1.2K Ω @ 0.5W

Isolated voltage: 2500 V rms

Throughput: High speed 500 KHz

• Dual-interrupt sources:

Change-of-state (COS) on any 16 DI lines of LSB

Change-of-state (COS) on any 16 DI lines of MSB

◆ General Specifications

- **Connector:** 37-pin D-type connector
- **Operating Temperature:** 0° C ~ 60° C
- **Storage Temperature:** -20° C ~ 80° C
- **Humidity:** 5 ~ 95%, non-condensing
- **Power Consumption:** +5V @ 300 mA for PCI-7233
+5V @ 550 mA for PCI-7233H
- **Dimension:** Compact size only 158 mm x 107 mm

1.4 Specifications of PCI-7234

◆ Isolated Digital Output

● Optical isolated Output channel

Numbers of Channel:	32 digital output
Output type:	Darlington transistors
Output Voltage:	open collector 5V (min.), up to 35V _{DC} (max.)
Sink Current:	<ul style="list-style-type: none">• 500 mA max @ 100 % duty, for one of the 8 transistors ON• 370 mA @ duty 10% for all transistors devices ON• 140 mA @ duty 50% for all transistors devices ON (pulse width 25ms for one duty cycle)
Isolated voltage:	5000 Vrms
Throughput:	10K Hz

◆ General Specifications

- **Connector:** 37-pin D-type connector
- **Operating Temperature:** 0° C ~ 60° C
- **Storage Temperature:** -20° C ~ 80° C
- **Humidity:** 5 ~ 95%, non-condensing
- **Power Consumption:** +5 V @ 180 mA (typical)
- **Dimension:** Compact size only 142 mm (H) X 98 mm (L)

1.5 Software Supporting

ADLINK provides versatile software drivers and packages for users' different approach to built-up a system. We not only provide programming library such as DLL for many Windows systems, but also provide drivers for many software package such as LabVIEW[®], HP VEE[™], DASyLab[™], InTouch[™], InControl[™], ISaGRAF[™], and so on.

All the software options are included in the ADLINK CD. The non-free software drivers are protected with serial licensed code. Without the software serial number, you can still install them and run the demo version for two hours for demonstration purpose. Please contact with your dealer to purchase the formal license serial code.

1.5.1 Programming Library

For customers who are writing their own programs, we provide function libraries for many different operating systems, including:

- **DOS Library:** Borland C/C++ and Microsoft C++, the functions descriptions are included in this user's guide.
- **Windows 95 DLL:** For VB, VC++, Delphi, BC5, the functions descriptions are included in this user's guide.
- **PCIS-DASK:** Include device drivers and DLL for **Windows 98, Windows NT and Windows 2000**. DLL is binary compatible across Windows 98, Windows NT and Windows 2000. That means all applications developed with PCIS-DASK are compatible across Windows 98, Windows NT and Windows 2000. The developing environment can be VB, VC++, Delphi, BC5, or any Windows programming language that allows calls to a DLL. The user's guide and function reference manual of PCIS-DASK are in the CD. Please refer the PDF manual files under the following directory: \\Manual_PDF\Software\PCIS-DASK
- **PCIS-DASK/X:** Include device drivers and shared library for **Linux**. The developing environment can be Gnu C/C++ or any programming language that allows linking to a shared library. The user's guide and function reference manual of PCIS-DASK/X are in the CD. (Manual_PDF\Software\PCIS-DASK-X.)

The above software drivers are shipped with the board. Please refer to the "Software Installation Guide" to install these drivers.

1.5.2 PCIS-LVIEW: LabVIEW[®] Driver

PCIS-LVIEW contains the VIs, which are used to interface with NI's LabVIEW[®] software package. The PCIS-LVIEW supports Windows 95/98/NT/2000. The LabVIEW[®] drivers are free shipped with the board. You can install and use them without license. For detail information about PCIS-LVIEW, please refer to the user's guide in the CD.

(\\Manual_PDF\Software\PCIS-LVIEW)

1.5.3 PCIS-VEE: HP-VEE Driver

The PCIS-VEE includes the user objects, which are used to interface with HP VEE software package. PCIS-VEE supports Windows 95/98/NT. The HP-VEE drivers are free shipped with the board. You can install and use them without license. For detail information about PCIS-VEE, please refer to the user's guide in the CD.

(\\Manual_PDF\Software\PCIS-VEE)

1.5.4 DAQBench™: ActiveX Controls

We suggest the customers who are familiar with ActiveX controls and VB/VC++ programming use the DAQBench™ ActiveX Control components library for developing applications. The DAQBench™ is designed under Windows NT/98. For more detailed information about DAQBench, please refer to the user's guide in the CD.

(\\Manual_PDF\Software\DAQBench\DAQBench Manual.PDF)

1.5.5 DASyLab™ PRO

DASyLab is an easy-to-use software package, which provides easy-setup instrument functions such as FFT analysis. Please contact us to get DASyLab PRO, which include DASyLab and ADLINK hardware drivers.

1.5.6 PCIS-DDE: DDE Server and InTouch™

DDE stands for Dynamic Data Exchange specifications. The PCIS-DDE includes the PCI cards' DDE server. The PCIS-DDE server is included in the ADLINK CD. It needs license. The DDE server can be used conjunction with any DDE client under Windows NT.

1.5.7 PCIS-ISG: ISaGRAF™ driver

The ISaGRAF WorkBench is an IEC1131-3 SoftPLC control program development environment. The PCIS-ISG includes ADLINK products' target drivers for ISaGRAF under Windows NT environment. The PCIS-ISG is included in the ADLINK CD. It needs license.

1.5.8 PCIS-ICL: InControl™ Driver

PCIS-ICL is the InControl driver which support the Windows NT. The PCIS-ICL is included in the ADLINK CD. It needs license.

1.5.9 PCIS-OPC: OPC Server

PCIS-OPC is an OPC Server, which can link with the OPC clients. There are many software packages on the market can provide the OPC clients now. The PCIS-OPC supports the Windows NT. It needs license.

2

Installation

This chapter describes the configurations of the PCI-7230/7233/7234. At first, the contents in the package and unpacking information that you should care about are described. The PCI-7230, 7233 or 7234 is plug-and-play and very easy to install into any PC system with PCI slots.

Please follow the follow steps to install the PCI-7230 family products.

- Check what you have (section 2.1)
- Unpacking (section 2.2)
- Check the PCB (section 2.3)
- Install the hardware (section 2.4)
- Install the software drivers and run utility to test (section 2.5)
- Cabling with external devices (section 2.6, 2.7)

2.1 What You Have

In addition to this *User's Manual*, the package includes the following items:

- 723X family Isolated Digital I/O Card
- ADLINK CD
- Software Installation Guide

If any of these items is missing or damaged, contact the dealer from whom you purchased the product. Save the shipping materials and carton in case you want to ship or store the product in the future.

2.2 Unpacking

Your PCI-7230, cPCI-7230, PCI-7233, PCI-7233H or PCI-7234 card contains sensitive electronic components that can be easily damaged by static electricity.

The card should be done on a grounded anti-static mat. The operator should be wearing an anti-static wristband, grounded at the same point as the anti-static mat. Inspect the card module carton for obvious damage. Shipping and handling may cause damage to your module. Be sure there are no shipping and handling damages on the module before processing.

After opening the card module carton, extract the system module and place it only on a grounded anti-static surface component side up.

Again inspect the module for damage. Press down on all the socketed IC's to make sure that they are properly seated. Do this only with the module place on a firm flat surface.

Note: DO NOT APPLY POWER TO THE CARD IF IT HAS BEEN DAMAGED.

You are now ready to install your PCI Card.

2.3 Hardware Installation Outline

PCI configuration

The PCI cards (or CompactPCI cards) are equipped with plug and play PCI controller, it can request base addresses and interrupt according to PCI standard. The system BIOS will install the system resource based on the PCI cards' configuration registers and system parameters (which are set by system BIOS). Interrupt assignment and memory usage (I/O port locations) of the PCI cards can be assigned by system BIOS only. These system resource assignments are done on a board-by-board basis. It is not suggested to assign the system resource by any other methods.

PCI slot selection

The PCI card can be inserted to any PCI slot without any configuration for system resource.

Installation Procedures

1. Turn off your computer
2. Turn off all accessories (printer, modem, monitor, etc.) connected to your computer.
3. Remove the cover from your computer.
4. Setup jumpers on the PCI or CompactPCI card.
5. Select a 32-bit PCI slot. PCI slot are short than ISA or EISA slots, and are usually white or ivory.
6. Before handling the PCI cards, discharge any static buildup on your body by touching the metal case of the computer. Hold the edge and do not touch the components.
7. Position the board into the PCI slot you selected.
8. Secure the card in place at the rear panel of the system.

2.4 Device Installation for Windows Systems

Once Windows 95/98/2000 has started, the Plug and Play function of Windows system will find the new NuDAQ/NuIPC cards. If this is the first time to install NuDAQ/NuIPC cards in your Windows system, you will be informed to input the device information source. Please refer to the "**Software Installation Guide**" for the steps of installing the device.

2.5 Connector Pin Assignment

2.5.1 PCI-7230 Pin Assignment

The pin assignment of the 37 pins D-type connector CN2, which is an isolated DIO signal connector, is shown below.

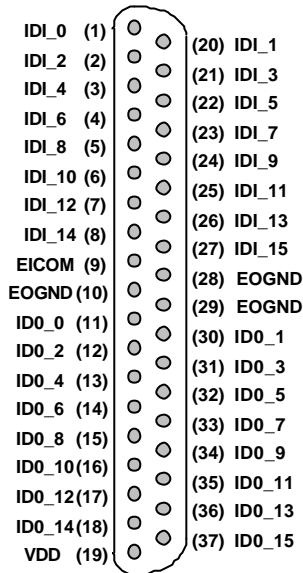

Legend:

- IDI_n**: Isolated digital input channel #n
- IDO_n**: Isolated digital output channel #n
- EICOM**: Common Ground or Common power of isolated input channels
- EOGND**: Ground return path of isolated output channels
- VDD**: Power supply of isolated output channels

Note: The VDD must provided by external power supply 10~30 VDC.

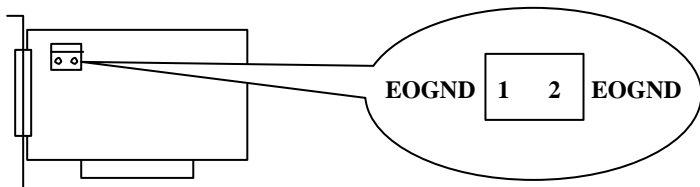

2.5.2 cPCI-7230 Pin Assignment

The pin assignment of the cPCI-7230's 50 pins SCSI-II type connector CN1 is shown in the following diagram.

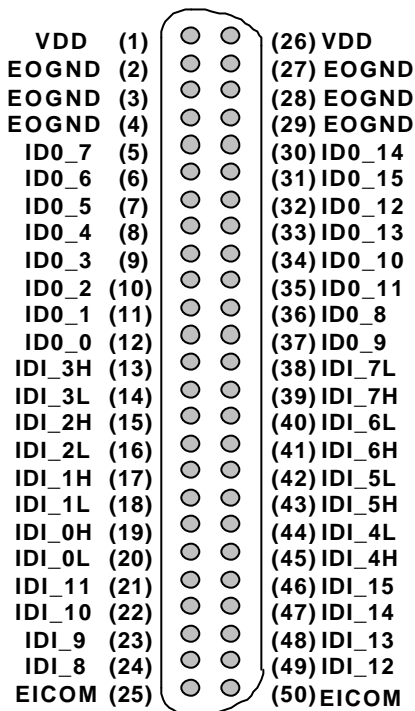

Legend:

- IDI_n*: Isolated digital input channel #n
- IDO_n*: Isolated digital output channel #n
- EICOM*: Common ground or common power of isolated input channels #8~15
- IDI_nH*: High input of isolated differential DI channel #n
- IDI_nL*: Low input of isolated differential DI channel #n
- EOGND*: Ground return path of isolated output channels
- VDD*: Power input signal for fly-wheel diode of DO channels

2.5.3 PCI-7233 Pin Assignment

The pin assignment of the 37 pins D-type connector CN1 is illustrated in the following.

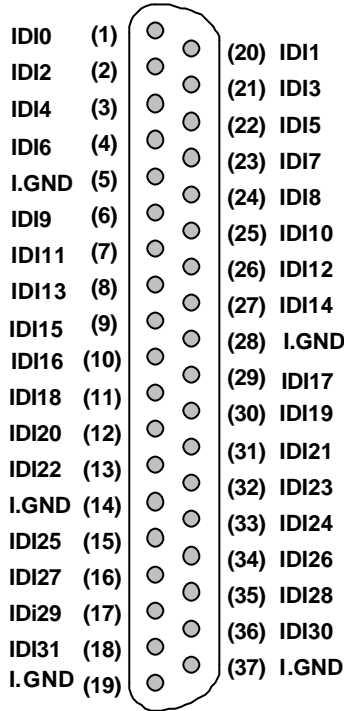

Legend:

- IDI *n*: Isolated digital input channel *n*
- I.GND: Isolated common ground

2.5.4 PCI-7234 Pin Assignment

The pin assignment of the 37 pins D-type connector CN2, which is an isolated DIO signal connector, is shown below.

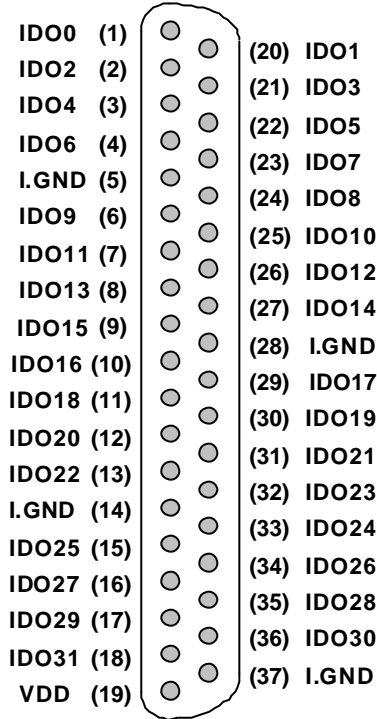

Legend:

- IDO n*: Isolated digital output signal channel *n*
- I.GND*: Isolated Ground for all isolated output channels
- VDD*: Power input signal for fly-wheel diode of DO channels

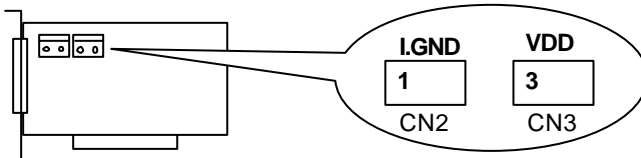

2.6 Termination Board Connection

The 723X boards are equipped with the DB-37 connector. The available termination boards include:

- ACLD-9137: A general purposed 37-pin screw terminal. The ACLD-9137 is with male DB-37 connector, which is used to directly attach on the PCI-6308.
- ACLD-9188: A general purposed 37-pin screw terminal, which equipped with heavy-duty screw terminal.
- DIN-37D: A general purposed 37-pin screw terminal with DIN-socket, which provide the easily installation socket. DIN-37D is shipped with a 37-pin cable

3

Registers Format

The detailed descriptions of the registers format are specified in this chapter. This information is quite useful for the programmers who wish to handle the card by low-level programming. However, we suggest user have to understand more about the PCI interface then start any low-level programming. In addition, the contents of this chapter can help users understand how to use software driver to manipulate this card.

3.1 PCI PnP Registers

This PCI card functions as a 32-bit PCI target device to any master on the PCI bus. There are three types of registers: PCI Configuration Registers (PCR), Local Configuration Registers (LCR) and PCI-6308 registers.

The PCR, which is compliant to the PCI-bus specifications, is initialized and controlled by the plug & play (PnP) PCI BIOS. User's can study the PCI BIOS specification to understand the operation of the PCR. Please contact with PCISIG to acquire the specifications of the PCI interface.

The PCI bus controller PCI-9050 is provided by PLX technology Inc. (www.plxtech.com). For more detailed information of LCR, please visit PLX technology's web site to download relative information. It is not necessary for users to understand the details of the LCR if you use the software library. The PCI PnP BIOS assigns the base address of the LCR. The assigned address is located at offset 14h of PCR.

The PCI-6308 registers are shown in the next section. The base address, which is also assigned by the PCI PnP BIOS, is located at offset 18h of PCR. Therefore, users can read the 18h of PCR to know the base address by using the BIOS function call.

Please do not try to modify the base address and interrupt which assigned by the PCI PnP BIOS, it may cause resource confliction in your system.

3.2 I/O Registers Format

The PCI-7230/cPCI-7230 requires one 32-bit address in the PC I/O address space. Table 3.1 shows the I/O address of each register with respect to the base address.

Address	Write	Read
Base (0 - 1)	Isolated DO	Isolated DI

Table 3.1. I/O Address Map of PCI-7230 and cPCI-7230

The PCI-7233 requires one 32-bit address in the PC I/O address space. Table 3.2 shows the address.

Address	Write	Read
Base (0 - 3)	--	Isolated DI

Table 3.2. I/O Address Map of PCI-7233/PCI-7233HS

The PCI-7234 requires one 32-bit address in the PC I/O address space. Table 3.3 shows the address.

Address	Write	Read
Base (0 - 3)	Isolated DO	--

Table 3.3. I/O Address Map of PCI-7234

Cautions:

1. All the above I/O ports are 32-bit width
2. 8-bit or 16-bit I/O access is NOT allowed.

3.3 Digital Input Register

There are total 16 and 32 digital input channels on the PCI-7230 (cPCI-7230) and PCI-7233 respectively. Each bit is corresponding to a signal on the digital input channel. The IDI_16~IDI_31 are only available on PCI-7233/PCI-7233H.

Address: BASE + 0 ~ BASE + 3

Attribute: read only

Data Format:

Bit	7	6	5	4	3	2	1	0
Base + 0	IDI_7	IDI_6	IDI_5	IDI_4	IDI_3	IDI_2	IDI_1	IDI_0
Base + 1	IDI_15	IDI_14	IDI_13	IDI_12	IDI_11	IDI_10	IDI_9	IDI_8
Base + 2	IDI_23	IDI_22	IDI_21	IDI_20	IDI_19	IDI_18	IDI_17	IDI_16
Base + 3	IDI_31	IDI_30	IDI_29	IDI_28	IDI_27	IDI_26	IDI_25	IDI_24

IDI_N: Isolated Digital Input CH *N*

3.4 Digital Output Register

There are total 16 and 32 digital output channels on the PCI-7230 (cPCI-7230) and PCI-7234 respectively. Each bit is corresponding to a signal on the digital output channel. The IDO_16~IDO_31 are only available on PCI-7234.

Address: BASE + 0 ~ BASE + 3

Attribute: write only

Data Format:

Bit	7	6	5	4	3	2	1	0
Base + 0	IDO_7	IDO_6	IDO_5	IDO_4	IDO_3	IDO_2	IDO_1	IDO_0
Base + 1	IDO_15	IDO_14	IDO_13	IDO_12	IDO_11	IDO_10	IDO_9	IDO_8
Base + 2	IDO_23	IDO_22	IDO_21	IDO_20	IDO_19	IDO_18	IDO_17	IDO_16
Base + 3	IDO_31	IDO_30	IDO_29	IDO_28	IDO_27	IDO_26	IDO_25	IDO_24

IDO_N: Isolated Digital Output CH *N*

4

Operation Theorem

4.1 Isolated Digital Input Circuits

The isolated digital output is an open collector transistor output. The input can accept voltage upto 24V. The input resistors on PCI-7230/7233 and cPCI-7230 are 1.2K Ω . The connection between outside signal and PCI-7230, cPCI-7230 and PCI-7233 is shown below.

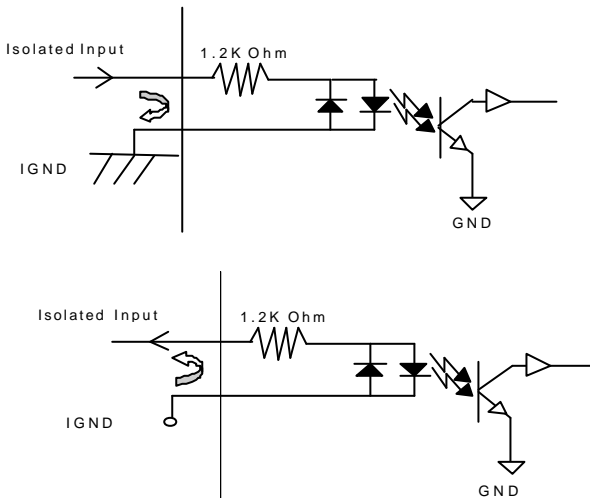

Figure 3.1 Input circuits of PCI-7230, cPCI-7230 and PCI-7233

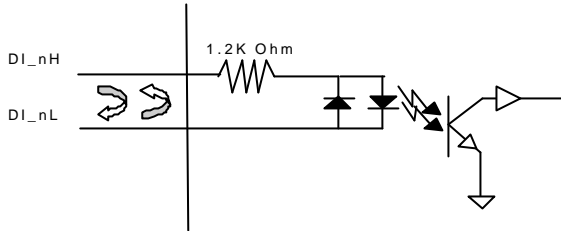

Figure 3.2 Differential Input circuits of cPCI-7233

4.2 Isolated Digital Output Circuits

The connection of isolated digital output is shown as following diagram. The PCI-7230 need external 10~30V DC power from the VDD pin to provide the power source of the digital output circuit. The cPCI-7230 and PCI-7234 is equipped with internal DC-DC converter.

On PCI-7230, an external voltage source, minimum 10V, maximum 35 VDC, is necessary to power the internal isolated circuits. It is connected with pin-19 of CN2. When the isolated digital output goes to high, the sink current will be from VDD.

On PCI-7234 and cPCI-7230, the VDD pin is used as “fly-wheel” diode, which can protect the driver if the loading is inductance loading such as relay, motor or solenoid. If the loading is resistance loading such as resistor or LED, the connection to fly-wheel diode is not necessary.

Therefore, the first step for connecting the output with external device is to distinguish the type of loading. For example, if the loading is LED or resistor, you can use the following wiring diagram.

The VDD is opened on PCI-7234 and cPCI-7230.

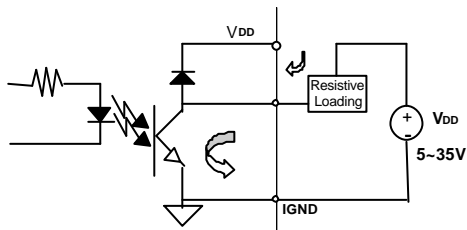

DO circuit of PCI-7230, PCI-7234, and cPCI-7230

If the loading is an inductance loading such as relay, you can use the following wiring diagram. The VDD must connect to the external power to form a fly-wheel current loop.

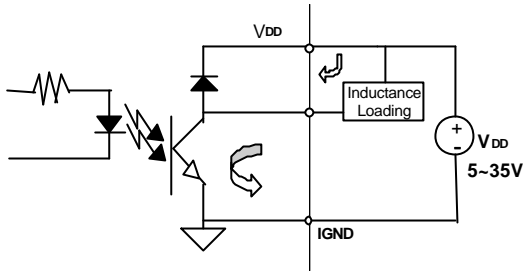

4.3 Change of State Detection

4.3.1 What is COS?

The COS (Change of State) means when the input state (logic level) is changed from low to high or from high to low. The COS detection circuit is used to detect the edge of level change. In the PCI-7233 card, the COS detection circuit is applied to all the 32 channels input channels. When anyone channel is changed, the COS detection circuit generate an interrupt request signal.

4.3.2 Structure of COS detection & Dual Interrupt System

The dual interrupt system is used in PCI-7233. Dual interrupt means the hardware can generate two interrupt request signals in the same time and the software can service these two request with ISR. Note that the dual interrupt do not mean the card occupy two IRQ levels. The two interrupt request signals (INT1 and INT2) are comes from COS detection output signal #1 and #2. The INT1 is inserted when any channel of 0 ~ 15 is changed. The INT2 is inserted when any channel of 16 ~ 31 is changed. Fig3.6.1 show the interrupt system.

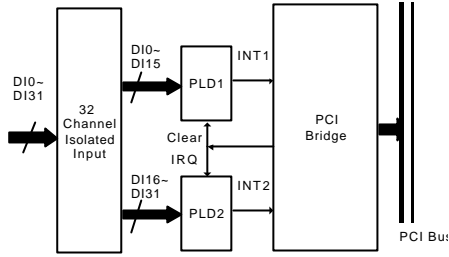
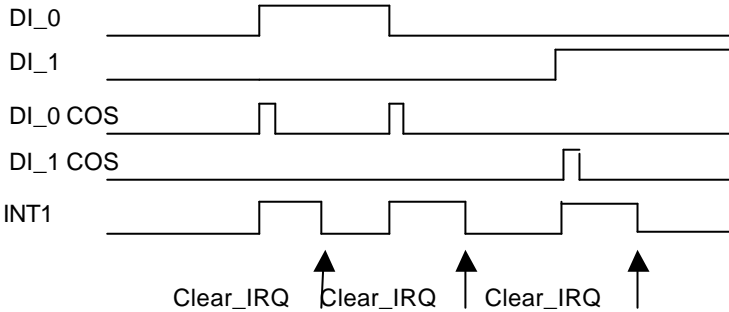

Fig.3.6.1 Dual Interrupt System of PCI-7233

4.3.3 COS Detection

The following timing is an example of the COS detection. Every DI signal's edge change can be detected. All the DI channels edge will be 'OR' together to generate the INT1 or INT2 IRQ signals.

If INT1 or INT2 irq Signals generate, the signal will be latch its state. The user can use the "_7233_CLR_IRQ" function to clear, INT1 or INT2 IRQ signal state.



5

C/C++ Libraries

This chapter describes the software library for operating this card. Only the functions in DOS library and Windows 95 DLL are described. Please refer to the PCIS-DASK function reference manual, which included in ADLINK CD, for the descriptions of the Windows 98/NT/2000 DLL functions.

The function prototypes and some useful constants are defined in the header files LIB directory (DOS) and INCLUDE directory (Windows 95). For Windows 95 DLL, the developing environment can be Visual Basic 4.0 or above, Visual C/C++ 4.0 or above, Borland C++ 5.0 or above, Borland Delphi 2.x (32-bit) or above, or any Windows programming language that allows calls to a DLL. It provides the C/C++, VB, and Delphi include files.

5.1 Libraries Installation

Please refer to the “**Software Installation Guide**” for the detail information about how to install the software libraries for DOS, or Windows 95 DLL, or PCIS-DASK for Windows 98/NT/2000.

The device drivers and DLL functions of Windows 98/NT/2000 are included in the PCIS-DASK. Please refer the PCIS-DASK user’s guide and function reference, which included in the ADLINK CD, for detailed programming information.

5.2 Programming Guide

5.2.1 Naming Convention

The functions of the NuDAQ PCI cards or NuIPC CompactPCI cards' software driver are using full-names to represent the functions' real meaning. The naming convention rules are:

In DOS Environment :

`_{hardware_model}_{action_name}`. e.g. `_7230_Initial()`.

All functions in PCI-7230 driver are with 7230 as {hardware_model}. But they can be used by PCI-7230 and cPCI-7230. All functions in PCI-7233 driver are with 7233 as {hardware_model}. But they can be used by PCI-7233 and PCI-7233H.

In order to recognize the difference between DOS library and Windows 95 library, a capital "W" is put on the head of each function name of the Windows 95 DLL driver. e.g. `W_7234_Initial()`.

5.2.2 Data Types

We defined some data type in `Pci_723X.h` (DOS) and `Acl_pci.h` (Windows 95). These data types are used by NuDAQ Cards' library. We suggest you to use these data types in your application programs. The following table shows the data type names and their range.

Type Name	Description	Range
U8	8-bit ASCII character	0 to 255
I16	16-bit signed integer	-32768 to 32767
U16	16-bit unsigned integer	0 to 65535
I32	32-bit signed integer	-2147483648 to 2147483647
U32	32-bit single-precision floating-point	0 to 4294967295
F32	32-bit single-precision floating-point	-3.402823E38 to 3.402823E38
F64	64-bit double-precision floating-point	-1.797683134862315E308 to 1.797683134862315E309
Boolean	Boolean logic value	TRUE, FALSE

5.3 Initialization

@ Description

The PCI-7230 or PCI-7233 or PCI-7234 cards must be initialized before using. The software library can control multiple PCI-7230/7233/7234 cards. Because in PCI bus architecture, the cards meet the plug and play specifications, the **IRQ** and **I/O address** are assigned by system BIOS directly.

@ Syntax

C/C++ (DOS)

```
U16 _7230_Initial(U16 *existCards, PCI_INFO *pciInfo )
U16 _7233_Initial(U16 *existCards, PCI_INFO *pciInfo )
U16 _7234_Initial(U16 *existCards, PCI_INFO *pciInfo )
```

C/C++ (Windows 95)

```
U16 W_7230_Initial (U16 *existCards, PCI_INFO *pciInfo)
U16 W_7233_Initial (U16 *existCards, PCI_INFO *pciInfo)
U16 W_7234_Initial (U16 *existCards, PCI_INFO *pciInfo)
```

Visual Basic (Windows 95)

```
W_7230_Initial (existCards As Integer, pciInfo As PCI_INFO) As Integer
W_7233_Initial (existCards As Integer, pciInfo As PCI_INFO) As Integer
W_7234_Initial (existCards As Integer, pciInfo As PCI_INFO) As Integer
```

@ Arguments:

existCards: The total number of installed PCI-7230 /7233/7234 cards. The returned value shows how many PCI-7230/7233/7234 cards are installed in your system.

pciinfo: It is a structure to memorize the PCI bus plug and play initialization information which is decided by p&p BIOS. The PCI_INFO structure is defined in `acl_pci.h`. The base I/O address and the interrupt channel number is stored in `pciinfo` which is for reference.

@ Return Code:

```
ERR_NoError
ERR_BoardNoInit
ERR_PCIBiosNotExist
```

5.4 Digital Input

@ Description

This function is used to read 16-bit digital inputs data from digital input port. You can get the 16 bits data from `_7230_DI` by using this function. You can get the 32 bits data from `_7233_DI` by using this function.

@ Syntax

C/C++ (DOS)

```
U16 _7230_DI( U16 cardNo, U16 *di_data )
U16 _7233_DI( U16 cardNo, U32 *di_data )
```

C/C++ (Windows 95)

```
U16 W_7230_DI ( U16 cardNo, U16 *diData)
U16 W_7233_DI ( U16 cardNo, U32 *diData)
```

Visual Basic (Windows 95)

```
W_7230_DI (ByVal cardNo As Integer, DIData As Integer) As Integer
W_7233_DI (ByVal cardNo As Integer, DIData As Integer) As Integer
```

@ Argument :

cardNo: card number to select board
di_data: return 16-bit value from digital port.

@ Return Code :

```
ERR_NoError
```

5.5 Digital Output

@ Description

This function is used to write data to digital output ports. There are 16 and 32 isolated digital outputs on the PCI-7230 and PCI-7234 respectively,

@ Syntax

C/C++ (DOS)

```
U16 _7230_DO(U16 cardNo, U16 do_data )
U16 _7234_DO(U16 cardNo, U32 do_data )
```

C/C++ (Windows 95)

```
U16 W_7230_DO ( U16 cardNo, U16 doData)
U16 W_7234_DO ( U16 cardNo, U32 doData)
```

Visual Basic (Windows 95)

```
W_7230_DO (ByVal cardNo As Integer, ByVal DOData As Integer) As
Integer
W_7234_DO (ByVal cardNo As Integer, ByVal DOData As Integer) As
Integer
```

@ Arguments:

cardNo : card number to select board
do_data : value will be written to digital output port

@ Return Code:

```
ERR_NoError
```

5.6 Interrupt Relative Functions

5.6.1 _723X_Set_INT_Control

@ Description

The PCI-7230/PCI-7233 is equipped with dual interrupts system, two interrupt sources can be generated and be checked by the software. This function is used to select and control PCI-7230/PCI-7233 interrupt sources by writing data to interrupt control register. For PCI-7230, the interrupt sources can be set as from channel 0 (INT1) or channel 1 (INT2) of digital input channel. For PCI-7233, the interrupt source can be set as from Channel 0 ~15 changing (INT1) or channel 16 ~ 31 changing (INT2) of digital input channels. Only one of interrupt sources can be set as enable.

@ Syntax

C/C++ (DOS)

```
void _7230_Set_INT_Control (U16 cardNo, U16 int1Flag, U16  
int2Flag)
```

```
void _7233_Set_INT_Control (U16 cardNo, U16 int1Flag, U16  
int2Flag)
```

C/C++ (Windows 95)

```
void W_7230_Set_INT_Control (U16 cardNo, U16 int1Flag, U16  
int2Flag)
```

```
void W_7233_Set_INT_Control (U16 cardNo, U16 int1Flag, U16  
int2Flag)
```

Visual Basic (Windows 95)

```
W_7230_Set_INT_Control (ByVal cardNo As Integer, ByVal int1Flag  
As Integer, ByVal int2Flag As Integer)
```

```
W_7233_Set_INT_Control (ByVal cardNo As Integer, ByVal int1Flag  
As Integer, ByVal int2Flag As Integer)
```

@ Argument

cardNo :	card number to select board
int1Flag :	INT1 setting; 0: disable, 1: enable
int2Flag :	INT2 setting; 0: disable, 1: enable

@ Return Code:

None

5.6.2 _723X_Get_IRQ_Status

@ Description

The PCI-7230/PCI-7233 has dual interrupts system. Two interrupt sources can be generated and be checked by the software. This function is used to distinguish which interrupt is inserted if both INT1 and INT2 interrupts are used.

@ Syntax

C/C++ (DOS)

```
void _7230_Get_IRQ_Status (U16 cardNo, U16 *int1Status, U16 *int2Status)
```

```
void _7233_Get_IRQ_Status (U16 cardNo, U16 *int1Status, U16 *int2Status)
```

C/C++ (Windows 95)

```
void W_7230_Get_IRQ_Status (U16 cardNo, U16 *int1Status, U16 *int2Status)
```

```
void W_7233_Get_IRQ_Status (U16 cardNo, U16 *int1Status, U16 *int2Status)
```

Visual Basic (Windows 95)

```
W_7230_Get_IRQ_Status (ByVal cardNo As Integer, int1Status As Integer, int2Status As Integer)
```

```
W_7233_Get_IRQ_Status (ByVal cardNo As Integer, int1Status As Integer, int2Status As Integer)
```

@ Argument

cardNo : card number to select board

int1Status :INT1 status; 0: interrupt is not from INT1, 1: interrupt is from INT1

int2Status : INT2 status; 0: interrupt is not from INT2, 1: interrupt is from INT2

@ Return Code:

None

5.6.3 _723X_CLR_IRQ

@ Description

This function is used to clear interrupt request. This function is only available in DOS library.

@ Syntax

C/C++ (DOS)

```
void _7230_CLR_IRQ (U16 cardNo)
void _7233_CLR_IRQ (U16 cardNo)
```

@ Argument

None

@ Return Code

None

5.6.4 Interrupt Enable

@ Description

This function is only available in Windows 95 driver. This function is used to start up the interrupt control. After calling this function, every time an IRQ generated, a software event is signaled. So that in your program, you can use wait operation to wait for the event. When the event is signaled, it means an interrupt is generated. Please refer to the sample program 7230int.c. Please note that the PCI-7234 do not have any interrupt.

@ Syntax

C/C++ (Windows 95)

```
U16 W_7230_INT_Enable (U16 cardNo, HANDLE *hEvent)
U16 W_7233_INT_Enable (U16 cardNo, HANDLE *hEvent)
```

Visual Basic (Windows 95)

```
W_7230_INT_Enable (ByVal cardNo As Integer, hEvent As Long) As Integer
W_7233_INT_Enable (ByVal cardNo As Integer, hEvent As Long) As Integer
```

@ Arguments

cardNo : card number to select board
hEvent : the address of an array of two handles. hEvent[0] and hEvent[1] are the events for interrupt signals INT1 and INT2 respectively.

@ Return Code:

```
ERR_NoError
ERR_BoardNoInit
```

5.6.5 Interrupt Disable

@ Description

This function is only available in Windows 95 driver. This function is used to disable the interrupt signal generation. Please refer to the sample program 7230int.c.

@ Syntax

C/C++ (Windows 95)

```
U16 W_7230_INT_Disable (U16 cardNo)
```

```
U16 W_7233_INT_Disable (U16 cardNo)
```

Visual Basic (Windows 95)

```
W_7230_INT_Disable (ByVal cardNo As Integer) As Integer
```

```
W_7233_INT_Disable (ByVal cardNo As Integer) As Integer
```

@ Arguments

cardNo : card number to select board

@ Return Code:

```
ERR_NoError
```

```
ERR_BoardNoInit
```

Product Warranty/Service

Seller warrants that equipment furnished will be free from defects in material and workmanship for a period of one year from the confirmed date of purchase of the original buyer and that upon written notice of any such defect, Seller will, at its option, repair or replace the defective item under the terms of this warranty, subject to the provisions and specific exclusions listed herein.

This warranty shall not apply to equipment that has been previously repaired or altered outside our plant in any way as to, in the judgment of the manufacturer, affect its reliability. Nor will it apply if the equipment has been used in a manner exceeding its specifications or if the serial number has been removed.

Seller does not assume any liability for consequential damages as a result from our products uses, and in any event our liability shall not exceed the original selling price of the equipment.

The equipment warranty shall constitute the sole and exclusive remedy of any Buyer of Seller equipment and the sole and exclusive liability of the Seller, its successors or assigns, in connection with equipment purchased and in lieu of all other warranties expressed implied or statutory, including, but not limited to, any implied warranty of merchant ability or fitness and all other obligations or liabilities of seller, its successors or assigns.

The equipment must be returned postage-prepaid. Package it securely and insure it. You will be charged for parts and labor if you lack proof of date of purchase, or if the warranty period is expired.