

TB-24P/24R/16P8R
DIN-24P/24R/24G
Relay Outputs or Isolated Inputs
Terminal Board Series
User's Guide



Recycled Paper

©Copyright 1995~2002 ADLINK Technology Inc.

All Rights Reserved.

Manual Rev 2.51: May, 28 2002

Part NO: 50-14001-201

The information in this document is subject to change without prior notice in order to improve reliability, design and function and does not represent a commitment on the part of the manufacturer.

In no event will the manufacturer be liable for direct, indirect, special, incidental, or consequential damages arising out of the use or inability to use the product or documentation, even if advised of the possibility of such damages.

This document contains proprietary information protected by copyright. All rights are reserved. No part of this manual may be reproduced by any mechanical, electronic, or other means in any form without prior written permission of the manufacturer.

Trademarks

TB-24P, TB-24R, TB-16P8R , DIN-24P, DIN-24R, DIN-24G are registered trademark of ADLINK Technology Inc., other product names mentioned herein are used for identification purposes only and may be trademarks and/or registered trademarks of their respective companies.

Getting Service from ADLINK

- ◆ **Customer Satisfaction is always the most important thing for ADLINK Tech Inc. If you need any help or service, please contact us and get it.**

ADLINK Technology Inc.			
Web Site	http://www.adlinktech.com		
Sales & Service	service@adlinktech.com		
Technical Support	NuDAQ + USBDAQ	nudaq@adlinktech.com	
	Automation	automation@adlinktech.com	
	NuIPC	nuipc@adlinktech.com	
	NuPRO/EBC	nupro@adlinktech.com	
TEL	+886-2-82265877	FAX	+886-2-82265717
Address	9F, No. 166, Jian Yi Road, Chungho City, Taipei, 235 Taiwan.		

- ◆ **Please inform or FAX us of your detailed information for a prompt, satisfactory and constant service.**

Detailed Company Information			
Company/Organization			
Contact Person			
E-mail Address			
Address			
Country			
TEL		FAX	
Web Site			
Questions			
Product Model			
Environment to Use	OS _____ Computer Brand _____ M/B: _____ CPU: Chipset: _____ BIOS: Video Card: Network Interface Card: Other:		
Challenge Description			
Suggestions for ADLINK			

Table of Contents

Chapter 1 TB-24P	1
1.1 Introductions.....	1
1.2 Specifications.....	1
1.3 Descriptions	2
Chapter 2 TB-24R	6
2.1 Introduction	6
2.2 Specification.....	7
2.3 Description.....	8
Chapter 3 TB-16P8R	12
3.1 Introduction	12
3.2 Specification.....	13
3.3 Description.....	14
Chapter 4 DIN-24P	18
4.1 Introductions.....	18
4.2 Specifications.....	18
4.3 Descriptions	19
Chapter 5 DIN-24R	24
5.1 Introduction	24
5.2 Specification.....	25
5.3 Description.....	26
Chapter 6 DIN-24G	31
6.1 Introduction	31
6.2 Specification.....	31
6.3 Description.....	32
Warranty Policy	34

How to Use This Guide

This manual is designed to help you use the TB-24P/24R/16P8R. The manual describes how to modify various settings on the TB-24P/24R/16P8R terminal board to meet your requirements.

- **Chapter 1**, "TB-24P : 24 Opto-isolated Digital Inputs Terminal Board", gives an overview of the TB-24P's features, description, and specifications.
- **Chapter 2**, "TB-24R : 24 Relay Outputs Terminal Board", gives an overview of the TB-24R's features, description, and specifications.
- **Chapter 3**, "TB-16P8R : 16 Opto-isolated Digital Inputs & 8 Relay Outputs Terminal Board", gives an overview of the TB-16P8R features, description, and specification
- **Chapter 4**, "DIN-24P: 24 Opto-isolated Digital Inputs Terminal Board", gives an overview of the DIN-24P's features, description, and specifications.
- **Chapter 5**, "DIN-24R: 24 Relay Outputs Terminal Board", gives an overview of the DIN-24R's features, description, and specifications.
- **Chapter 6**, "DIN-24G: Terminal Board with 24 module rack for connecting I/O modules, gives an overview of the DIN-24G features, description, and specification

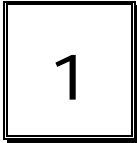

TB-24P

24 Opto-isolated Digital Inputs Terminal Board

1.1 Introductions

TB - 24P is an input extension board with 24 isolated photo couplers. CN1, CN2, CN3 and CN4 are terminal blocks to connect with external devices. CN5 is a 50 pins connector to connect with opto-22 compatible connector, such as ACL-7124, ACL-7122, PET-48DIO, PCI-7248, PCI-7296 etc. All input ports are with LED indicators.

1.2 Specifications

Indication Display:	24 LEDs for input indication
Input electrical characteristically	
Logic input low voltage:	<0.8 V DC
Logic input high voltage:	+5V DC to +24V DC
Logic input high current:	up to 40mA
Logic "1":	Voltage input high
Logic "0":	Voltage input low
Isolation voltage: 2500V DC	

1.3 Descriptions

TB-24P has 5 connectors and 24 LEDs. The following Figure shows their placement on TB-24P.

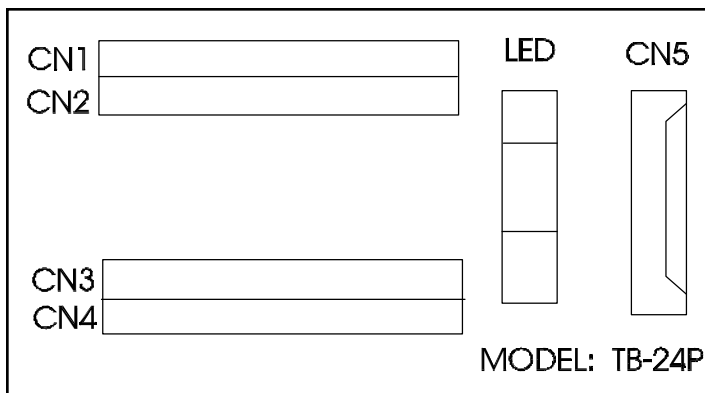

Outline of TB-24P

TB-24P has 24 LEDs to indicate input status, the LED mapping and logic definition are shown as the following table.

LED No.	Indication Display	Color of LED	Channel
LED 0	PA0	GREEN	CH0
LED 7	PA7	GREEN	CH7
LED8	PB0	YELLOW	CH8
LED 15	PB7	YELLOW	CH15
LED 16	PC0	RED	CH16
LED 23	PC7	RED	CH23

LED mapping table

Logic "1"	LED " ON"
Logic "0"	LED "OFF"

Logic define

Each input channel can connect with opto-22 compatible Digital I/O board, such as ACL-7122, PET-48DIO, PCI-7248/96 etc. directly or through photo coupler, and the upper of each photo coupler has a jumper to select.

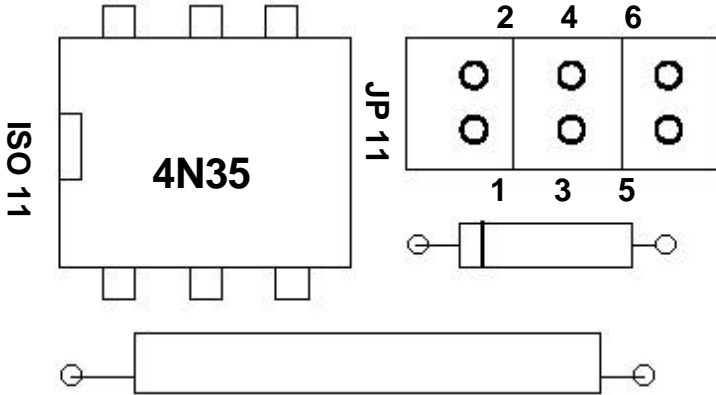

The positioning of each setting jumper

Each input port has two mini jumpers for setting.

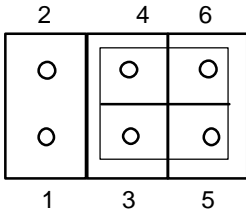

- * Photo Coupler is used
- * It is for voltage input
- (Factory setting)**

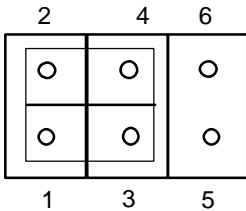

- * Photo coupler is not used
- * It is for “dry contact”

The input circuit is shown as the following figure.

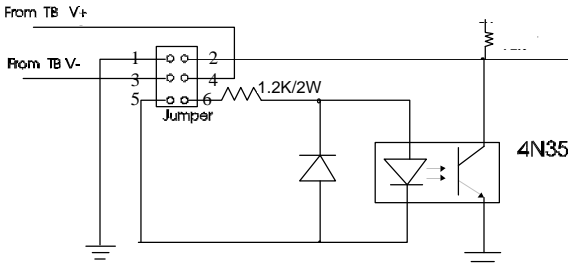

Each input channel has two terminal blocks. The pin definition of the terminal block is shown as the following tables.

CN1

CH12	CH14	CH16	CH18	CH20	CH22
V	V	V	V	V	V
+	-	+	-	+	-

CN2

CH13	CH15	CH17	CH19	CH21	CH23
V	V	V	V	V	V
+	-	+	-	+	-

CN3

CH0	CH2	CH4	CH6	CH8	CH10
V	V	V	V	V	V
+	-	+	-	+	-

CN4

CH1	CH3	CH5	CH7	CH9	CH11
V	V	V	V	V	V
+	-	+	-	+	-

The CN5 is an opto-22 compatible connector, which pin assignment is shown as the following figure.

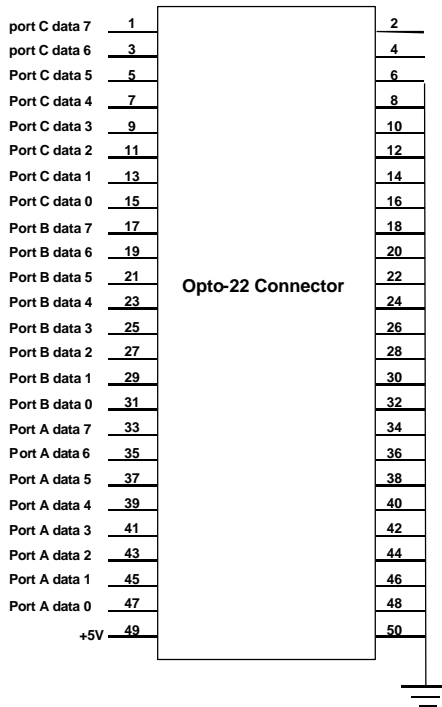

CN5 pins definition

2

TB-24R 24 Relay Outputs Terminal Board

2.1 Introduction

TB - 24R is an output extension board with 24 relays. CN1, CN2, CN3 and CN4 are terminal blocks to connect with external devices. CN5 connect with external power source. TB-24R/12 uses +12V power, but TB-24R/24 uses +24V power. CN6 is used to connect the opto-22 compatible connector, such as ACL-7122, ACL-7124, PET-48DIO, PCI-7248/96 etc.

2.2 Specification

Indication display: 24 LEDs

Relay type: High sensitive 1500 V FCC surge with standing miniature relay.

Relay form: SPDT

Contact rating:

Max. switching power	60 W, 125 VA
Max. switching voltage	220 V DC, 250 V AC
Max. switching current	2 A DC, AC
Max. carrying current	3 A DC, AC
UL/CSA rating	0.6 A 125 V AC
UL/CSA rating	0.6 A 110 V DC
UL/CSA rating	2 A 30 V DC

Coil voltage: 12 V DC for TB-24R/12
24V DC for TB-24R/24

2.3 Description

TB-24R has six connectors. The figure as below is the placement of these connectors.

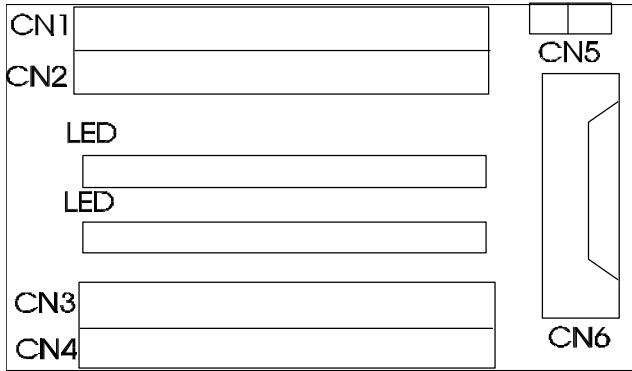

Outline of TB - 24R

The 24 LEDs are the indicators of output channels. The mapping of LED and Logic definition are shown as the following table.

LED No.	Indication Display	Color of LED	Channel
LED0	PA0	GREEN	CH0
LED7	PA7	GREEN	CH7
LED8	PB0	YELLOW	CH8
LED15	PB7	YELLOW	CH15
LED16	PC0	RED	CH16
LED23	PC7	RED	CH23

LEDs Mapping Table

Logic "0"	LED "ON"
Logic "1"	LED "OFF"

Logic Define Table

CN1, CN2, CN3 and CN4 are terminal blocks to be connected with external device.

Each output channel has three terminals, the definition of each terminal is shown as the following figure.

Channel No.		
Common	Normal close	Normal open

Terminal block definition of each channel

The mapping of channel number and connector number is shown as the following figure.

CN1	CH12	CH14	CH16	CH18	CH20	CH22
CN2	CH13	CH15	CH17	CH19	CH21	CH23

CN3	CH0	CH2	CH4	CH6	CH8	CH10
CN4	CH1	CH3	CH5	CH7	CH9	CH11

The relationship of channel number and CN1,CN2,CN3,CN4

The CN5 is used to connect with external power source. The following figure shows CN5 connection.

+24V for TB-24R/24

+12V for TB-24R/12

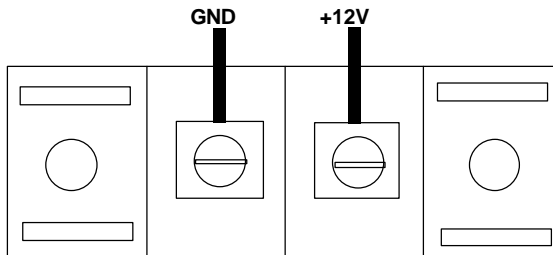

CN5 Connection

The output circuits are shown as the following figure.

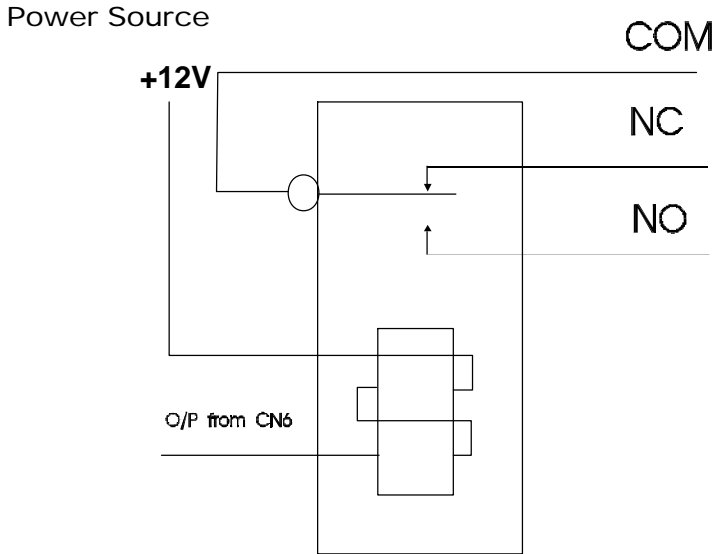

TB-24R/12:Relay is DSIE-S-DC12V, it need +12V power source

TB-24R/24:Relay is DSIE-S-DC24V, it need +24V power source

The CN6 is used to connect with opto-22 compatible connector, such as ACL-7122, ACL-7124, or PET-48DIO, PCI-7248/96 etc. the pin assignment is defined as the following figure.

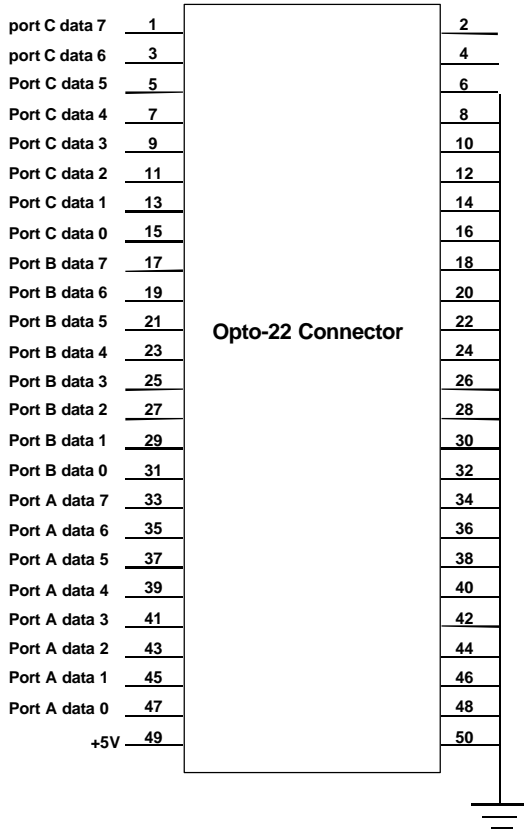

CN6 pin definition

3

TB-16P8R 16 Opto-isolated Inputs & 8 Relay Outputs Terminal Board

3.1 Introduction

The TB-16P8R is input / output extension board with 16 input channels and 8 output channels. All inputs channels are with photo couplers, and all outputs are with relays. Terminal blocks on TB-16P8R are used to connect with external devices. TB-16P8R has the same photo coupler circuitry as the TB-24P, please refer to TB-24P for details.

3.2 Specification

Indication Display:	24 LEDs for input/output indication
Input electrical characteristically:	
Logic input low voltage:	< 0.8 V DC
Logic input high voltage:	+3V DC to +24V DC
Logic input high current:	6.3mA to 50mA
Logic "1":	Voltage input high
Logic "0":	Voltage input low
Isolation voltage:	2500V DC
Relay type:	High sensitive 1500 V FCC surge with standing miniature relay.
Relay form:	SPDT
Contact rating:	

Max. switching power	60 W, 125 VA
Max. switching voltage	220 V DC, 250 V AC
Max. switching current	2 A DC, AC
Max. carrying current	3 A DC, AC
UL/CSA rating	0.6 A 125 V AC
UL/CSA rating	0.6 A 110 V DC
UL/CSA rating	2 A 30 V DC

Coil voltage:	12 V DC for TB-16P8R/12 24 V DC for TB-16P8R/24
---------------	--

3.3 Description

TB-16P8R has 6 connectors and 24 LEDs. The following Figure shows the placement of TB-16P8R.

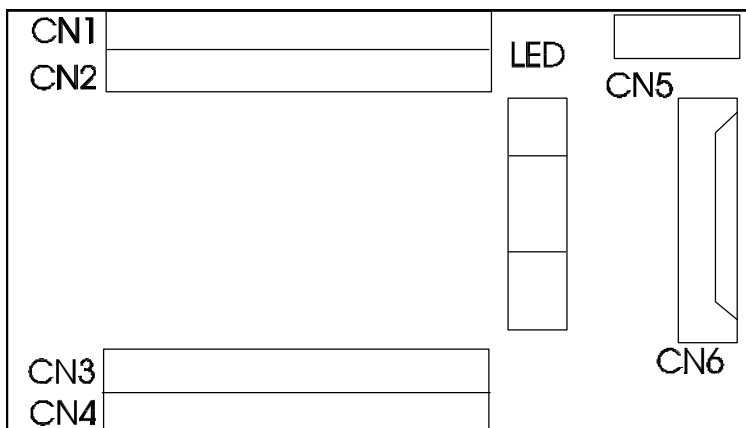

TB-16P8R Outline

The CN5 is used to connect with external power source.

The CN1, CN2 are terminal blocks for input connection.

The CN3, CN4 are terminal blocks for output connection.

The CN6 is used to connect with the opto-22 compatible connector, such as ACL-7122 or PET-48DIO PCI-7248/96. (Please set the I/O mode as mode 7).

The design of input port is same as TB-24P. JP8 to JP23 are for dry contact or using photo coupler setting.

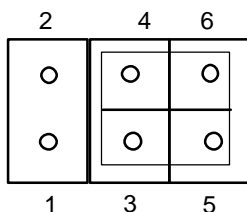

**Photo Coupler is used Voltage Input
(Factory setting)**

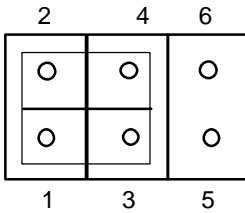

Photo Coupler is not used

The input port of TB-16P8R is the same as TB-24P. Each input channel has two terminal blocks. The pin definition of CN1, CN2 is showing as following figure.

CN1

CH8		CH10		CH12		CH14		CH16		CH18		CH20		CH22	
V	V	V	V	V	V	V	V	V	V	V	V	V	V	V	V
+	-	+	-	+	-	+	-	+	-	+	-	+	-	+	-

CN2

CH9		CH11		CH13		CH15		CH17		CH19		CH21		CH23	
V	V	V	V	V	V	V	V	V	V	V	V	V	V	V	V
+	-	+	-	+	-	+	-	+	-	+	-	+	-	+	-

The output port of TB-16P8R is the same as TB-24R. Each output channel has three terminals.

Channel No.		
Common	Normal close	Normal open

The relationship of channel number and CN3, CN4 is shown as the following table.

CH3	CH0	CH2	CH4	CH6
CH4	CH1	CH3	CH5	CH7

The relationship of LED, channel and output port is showing as table.

LED No.	Indication Display	Color of LED	Channel
LED 0	PA0	GREEN	CH0
LED 7	PA7	GREEN	CH7
LED8	PB0	YELLOW	CH8

LED 15	PB7	YELLOW	CH15
LED 16	PC0	RED	CH16
LED 23	PC7	RED	CH23

The CN5 is to connect external power source. Figure shows connecting.

+24V for TB-24R/24
+12V for TB-24R/12

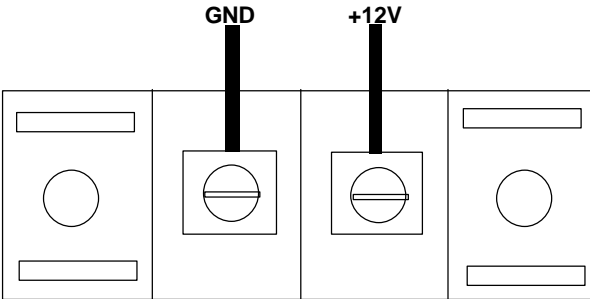

TB-16P8R/12: Relay is DSIE-S-DC12V and it needs +12V power source

TB-16P8R/24: Relay is DSIE-S-DC24V and it needs +24V power source

The CN6 is an opto-22 compatible connector. The following figure shows the pin definition of CN6.

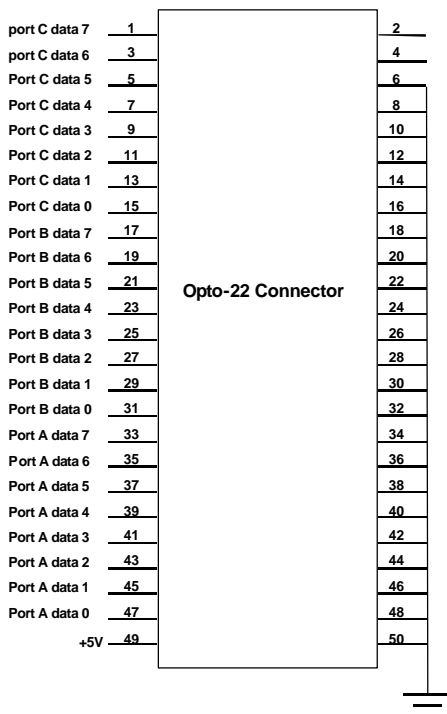

CN6 pin definition

PORT A: Relay Output

PORT B:C : Opto-isolated Input

The 8 relay output channels (8R) connect with PET-48DIO port A through CN6, and 16 photo coupler input channels (16p) connect with PET-48DIO port B,C through CN6.

4

DIN-24P

24 Opto-isolated Digital Inputs

Terminal Board

4.1 Introductions

DIN - 24P is an input extension board with 24 isolated photo couplers. CN7 and CN8 are terminal blocks used to connect with external devices. CN5 is a 50 pin connector used to connect with opto-22 compatible connector, such as ACL-7124, ACL-7122, PET-48DIO... etc, and CN6 is a 50-pin connector used to connect with 50-pin SCSI connector, such as ND-6058. All input channels are with LED indicators.

4.2 Specifications

Indication Display:	24 LEDs for input indication
Input electrical characteristically	
Logic input low voltage:	<0.8 V DC
Logic input high voltage:	+5V DC to +24V DC
Logic input high current:	up to 40mA
Logic "1":	Voltage input high
Logic "0":	Voltage input low
Isolation voltage: 5000Vrms	

4.3 Descriptions

DIN-24P has 4 connectors and 24 LEDs. The following figure shows their placement on DIN-24P.

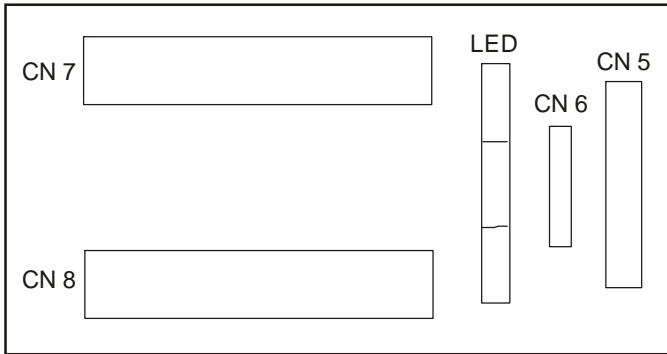

Outline of DIN-24P

DIN-24P has 24 LEDs to indicate input status, the LED mapping and logic definition are show as the following table.

LED No.	Indication Display	Color of LED	Channel
LED 0	PA0	YELLOW	CH0
LED 7	PA7	YELLOW	CH7
LED8	PB0	GREEN	CH8
LED 15	PB7	GREEN	CH15
LED 16	PC0	RED	CH16
LED 23	PC7	RED	CH23

LED mapping table

Logic "1"	LED " ON"
Logic "0"	LED "OFF"

Logic define

The DIN-24P can be connected with opto-22 compatible digital I/O board, such as ACL-7122 and PET-48DIO, PCI-7248/96, or digital I/O module equipped with 50-pin SCSI type connector such as ND-6058. Each channel can be connect to external device directly or through a photo coupler, and each photo coupler has a jumper to select the input configuration.

The positioning of each setting jumper

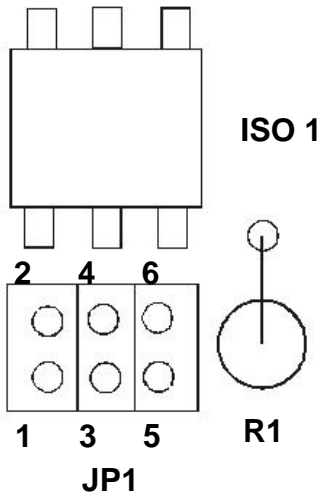

Each input port has two mini jumpers for setting.

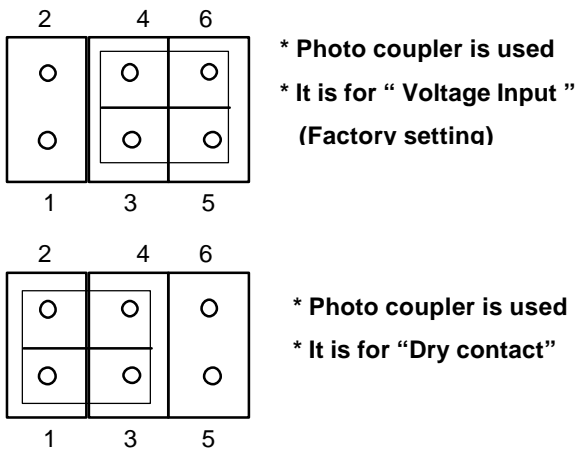

The input circuit shows as figure.

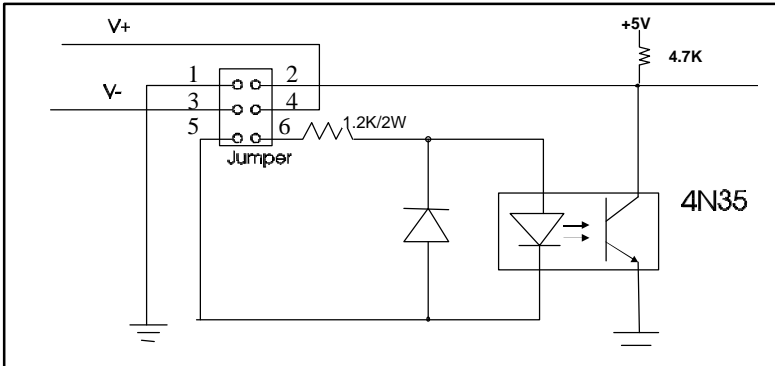

The DIN-24P has two terminal blocks. The terminal block pin definitions are shown as the following figure.

CN7

CH22		CH20		CH18		CH16		CH14		CH12	
V	V	V	V	V	V	V	V	V	V	V	V
+	-	+	-	+	-	+	-	+	-	+	-
CH23		CH21		CH19		CH17		CH15		CH13	
V	V	V	V	V	V	V	V	V	V	V	V
+	-	+	-	+	-	+	-	+	-	+	-

CN8

CH10		CH8		CH6		CH4		CH2		CH0	
V	V	V	V	V	V	V	V	V	V	V	V
+	-	+	-	+	-	+	-	+	-	+	-
CH11		CH9		CH7		CH5		CH3		CH1	
V	V	V	V	V	V	V	V	V	V	V	V
+	-	+	-	+	-	+	-	+	-	+	-

The CN5 is an opto-22 compatible connector, which pin assignment is shown as the following figure.

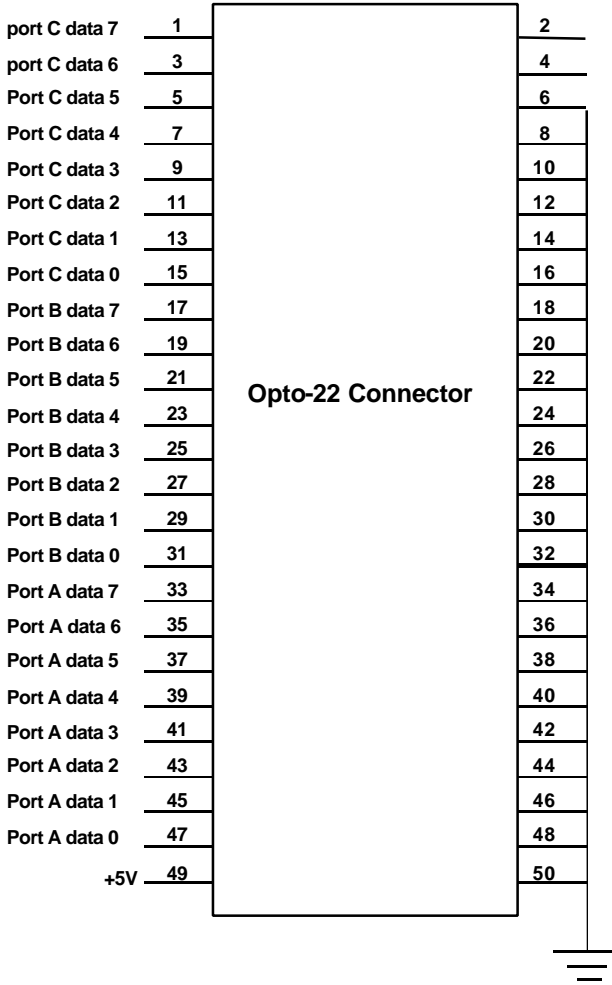

CN5 pin definition

The CN6 is an 50-pin SCSI connector, which pin assignment is shown as the following figure.

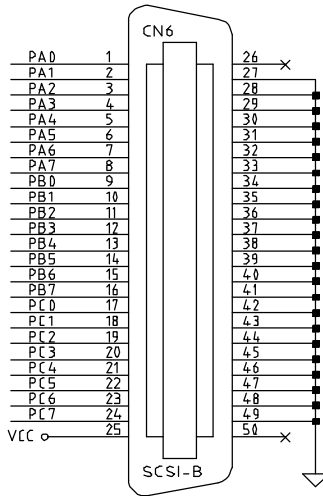

CN6 pin definition

DIN-24R

24 Relay Outputs Terminal Board

5.1 Introduction

DIN - 24R is an output extension board with 24 relays. J1 and J2 are terminal blocks to connect with external devices. CN9 connects with external power source. DIN-24R/12 uses +12V power, and DIN-24R/24 uses +24V power, CN6 connects to opto-22 compatible boards, such as ACL-7122, ACL-7124, PET-48 DIO, PCI-7248/96, etc. CN7 connects to digital output boards with 50-pin SCSI connector, such as ND-6058.

5.2 Specification

Indication display: 24 LEDs

Relay type: High sensitive 110V DC (125 VAC)
Surge withstanding miniature relay.

Relay form: SPDT

Contact rating:

Max. switching power	60 W, 125 VA
Max. switching voltage	220 V DC, 250 V AC
Max. switching current	2 A DC, 0.6AC
Max. carrying current	3 A DC, AC
UL/CSA rating	0.6 A 125 V AC
UL/CSA rating	0.6 A 110 V DC
UL/CSA rating	2 A 30 V DC

Coil voltage: 12 V DC for DIN-24R/12
24 V DC for DIN-24R/24

5.3 Description

DIN-24R has five connectors. The following figure shows the placement of these connectors.

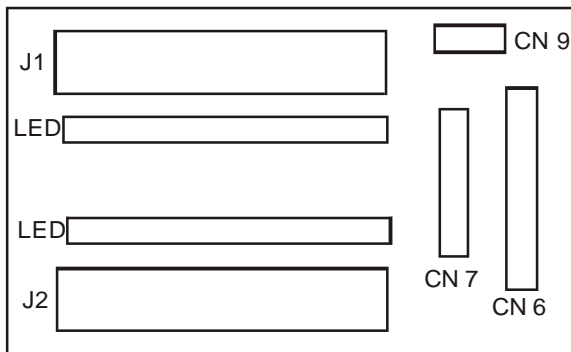

Outline of DIN - 24R

The 24 LEDs are indicators of output channels. The mapping of LED and logic definition are shown as the following table.

LED No.	Indication Display	Color of LED	Channel
LED0	PA0	RED	CH0
LED7	PA7	RED	CH7
LED8	PB0	YELLOW	CH8
LED15	PB7	YELLOW	CH15
LED16	PC0	GREEN	CH16
LED23	PC7	GREEN	CH23

LEDs Mapping Table

Logic "0"	LED "ON"
Logic "1"	LED "OFF"

Logic Define Table

J1 and J2 are terminal blocks to connect with external device.

Each output channel has three terminals, which definition is shown as the following figure.

Channel No.		
Common	Normal close	Normal open

Terminal definition of each channel

The relationship of channel number and J1, J2 are shown as the following figure.

J1

CH22	CH20	CH18	CH16	CH14	CH12
CH23	CH21	CH19	CH17	CH15	CH13

J2

CH10	CH8	CH6	CH4	CH2	CH0
CH11	CH9	CH7	CH5	CH3	CH1

The CN9 is used to connect with external power source. The following figures show CN9 connection.

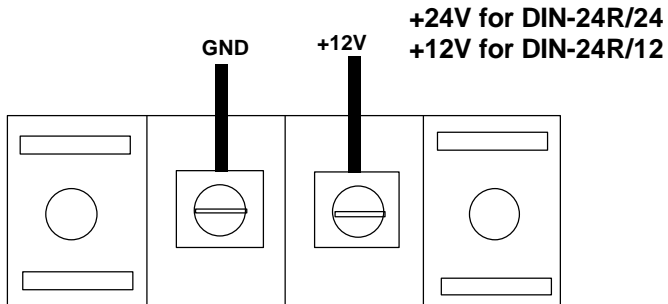

CN5 connection

The output circuit is shown as the following figure.

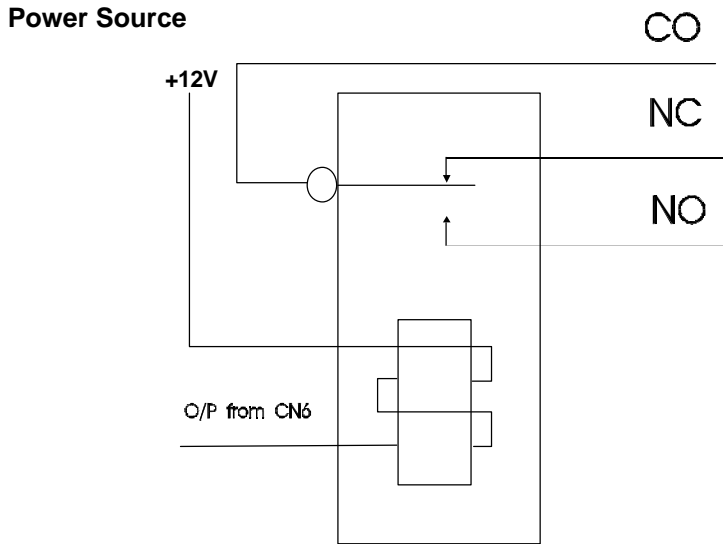

DIN-24R/12: Relay is DSIE-S-DC12V, and it need +12V power source

DIN-24R/24: Relay is DSIE-S-DC24V, and it need +24V power source

The CN6 is used to connect with opto-22 compatible boards, such as ACL-7122, ACL-7124, PET-48DIO, etc. Its pin assignment is defined as the following figure.

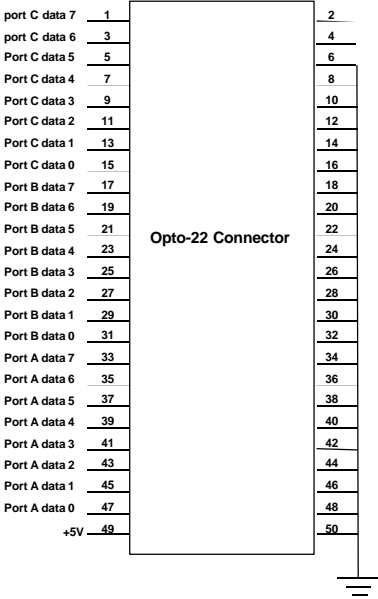

CN6 pins define figure

The CN7 is used to connect with DIO board with 50-pin SCSI connector, such as ND-6058. Its pin assignment is defined as the following figure.

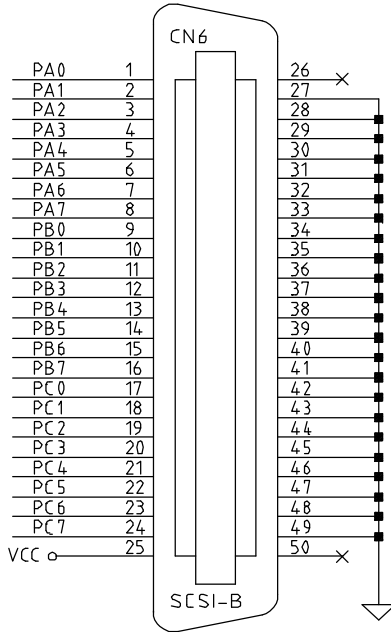

CN7 pin definition

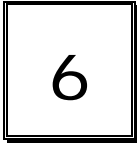

DIN-24G

24 I/O Module Terminal Board

6.1 Introduction

The DIN-24G is I/O module terminal board with 24 positions to mount I/O module. The types of module include DC input, DC output, AC input, AC output. And it could extend the application of DI/O cards and DI/O modules.

6.2 Specification

1. Supply 24 position mount I/O modules.
2. Supply terminal blocks to connect with external device.
3. Support 50 pin straight header connector to connect with DAQ boards.

6.3 Description

DIN-24G has 6 connectors. The following Figure shows the placement on Din-24G.

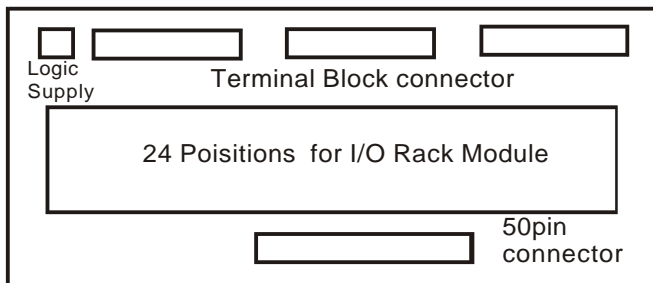

DIN-24G Outline

The Logic Supply is to supply logic power for the operation of modules.

The Terminal Block is terminal block for field wiring.

The 50-pin connector is to connect the NuDAQ or NuDAM.

The 24 positions are to connect with I/O rack module.

The following is pin definition of 50-pin connector.

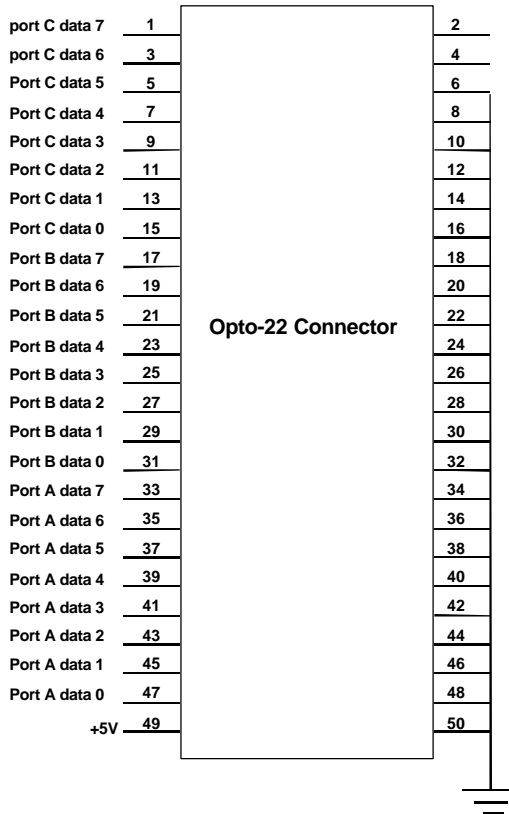

Warranty Policy

Thank you for choosing ADLINK. To understand your rights and enjoy all the after-sales services we offer, please read the following carefully.

1. Before using ADLINK's products, please read the user manual and follow the instructions exactly. When sending in damaged products for repair, please attach an RMA application form.
2. All ADLINK products come with a two-year guarantee, free of repair charge.

The warranty period starts from the product's shipment date from ADLINK's factory

Peripherals and third-party products not manufactured by ADLINK will be covered by the original manufacturers' warranty

End users requiring maintenance services should contact their local dealers. Local warranty conditions will depend on the local dealers. Our repair service does not cover two-year guarantee while damages are caused by the following:

- a. Damage caused by not following instructions on user menus.
- b. Damage caused by carelessness on the users' part during product transportation.
- c. Damage caused by fire, earthquakes, floods, lightning, pollution and incorrect usage of voltage transformers.
- d. Damage caused by unsuitable storage environments with high temperatures, high humidity or volatile chemicals.
- e. Damage caused by leakage of battery fluid when changing batteries.
- f. Damages from improper repair by unauthorized technicians.
- g. Products with altered and damaged serial numbers are not entitled to our service.
- h. Other categories not protected under our guarantees. Customers are responsible for the fees regarding transportation of damaged products to our company or to the sales office.

5. To ensure the speed and quality of product repair, please download an RMA application form from our company website www.adlinktech.com. Damaged products with RMA forms attached receive priority.

For further questions, please contact our FAE staff.

ADLINK: service@adlinktech.com

Test & Measurement Product Segment: NuDAQ@adlinktech.com

Automation Product Segment: Automation@adlinktech.com

Computer & Communication Product Segment: NuPRO@adlinktech.com ;
NuIPC@adlinktech.com